

Name _____

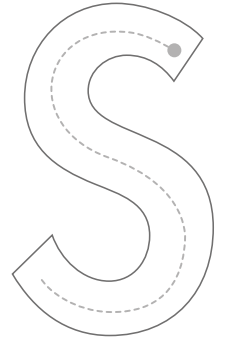

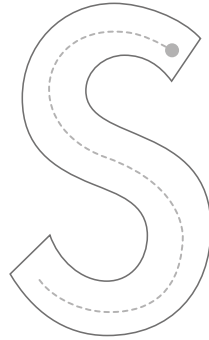

Name _____

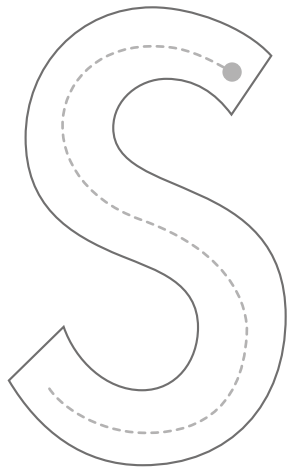
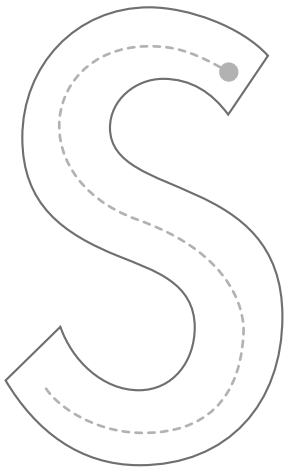
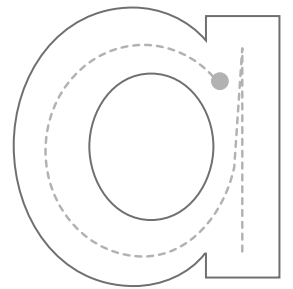
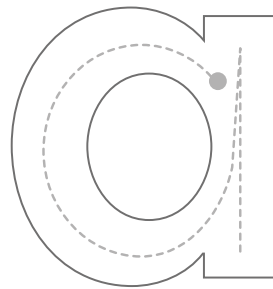
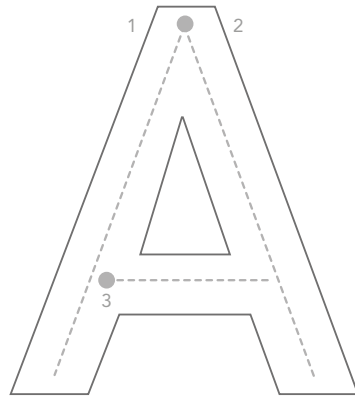
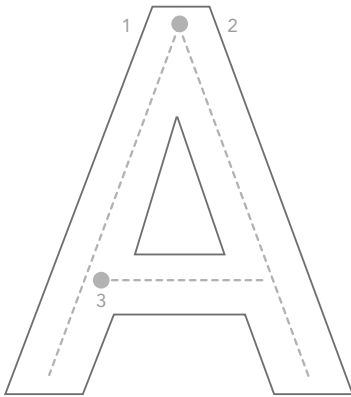
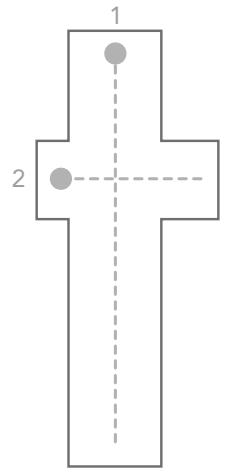
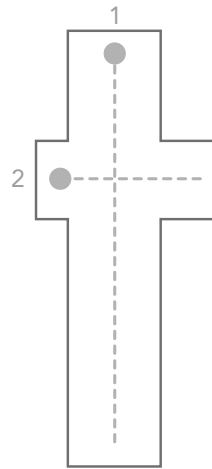
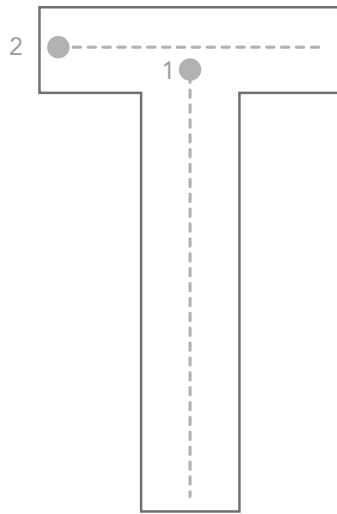
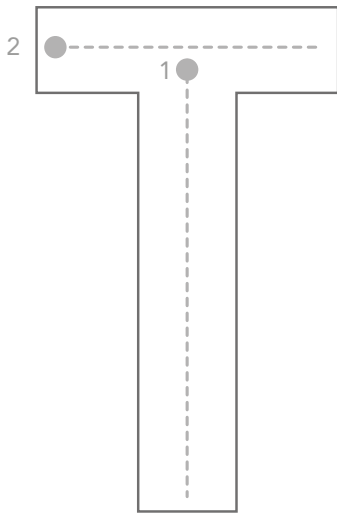

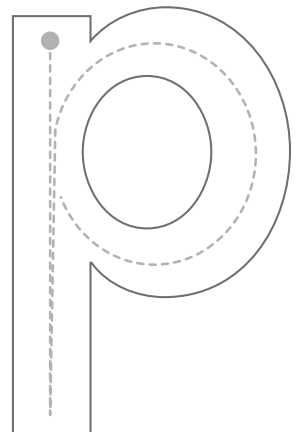
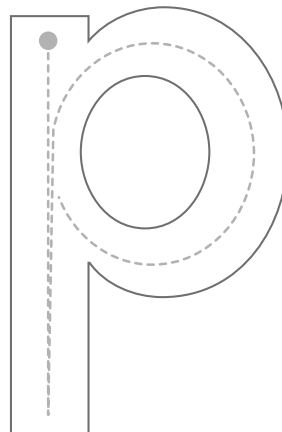
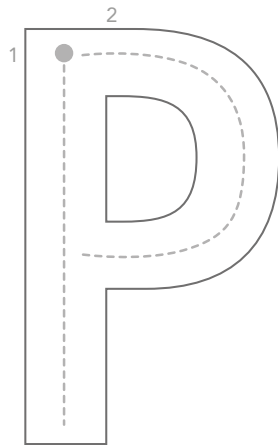
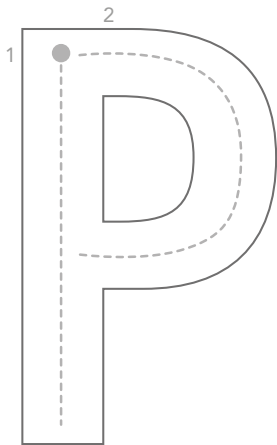

Name _____

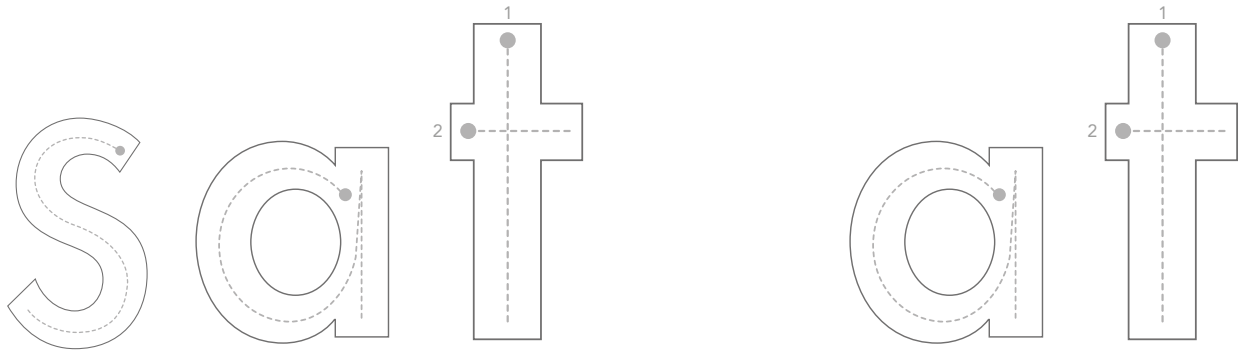

sat _____

at _____

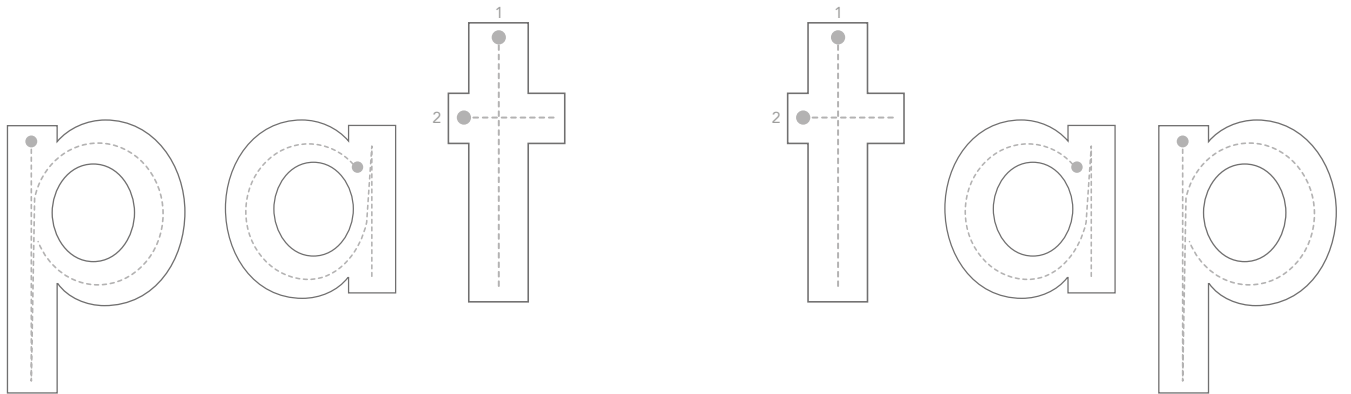

pat _____

tap _____

Name _____

Pam

am

Sam

map

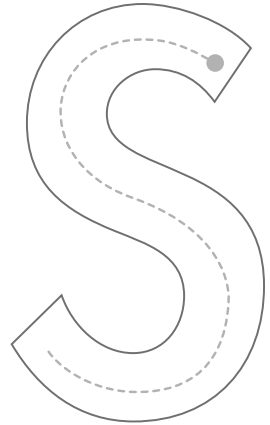
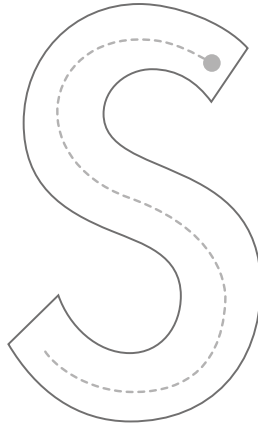
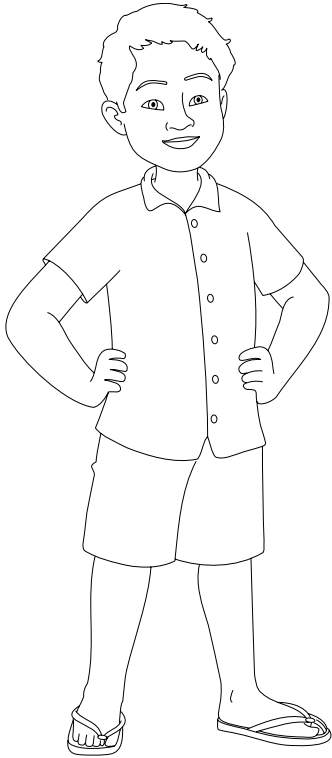

Sam

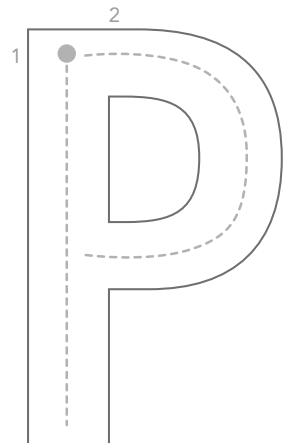
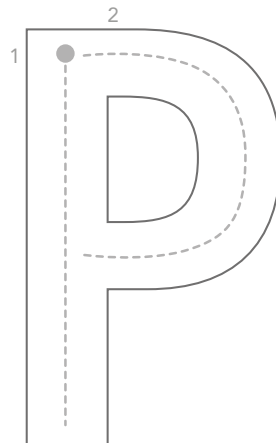
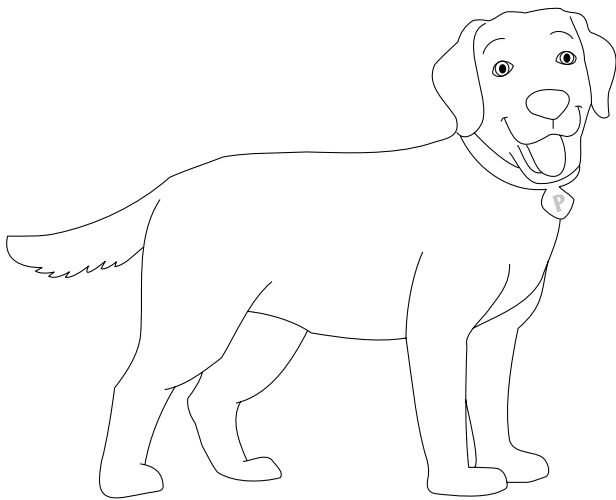

Pam

Name _____

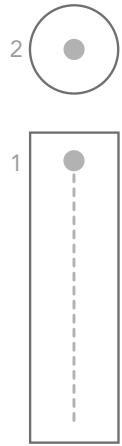
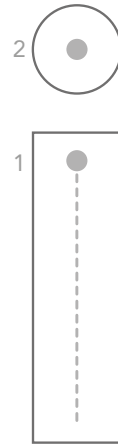
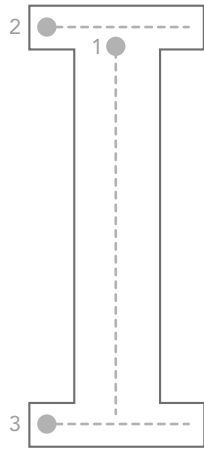
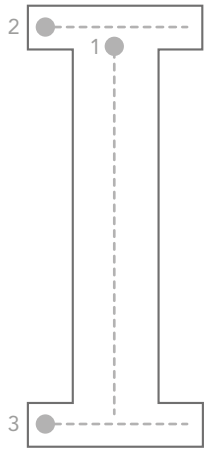

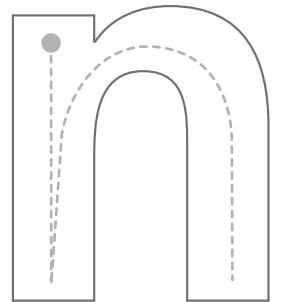
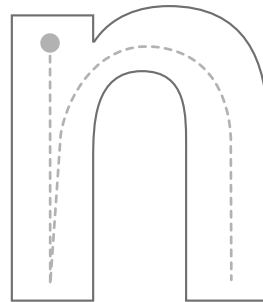
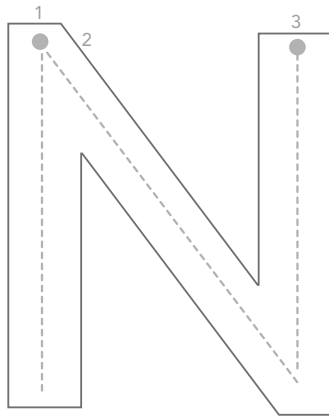
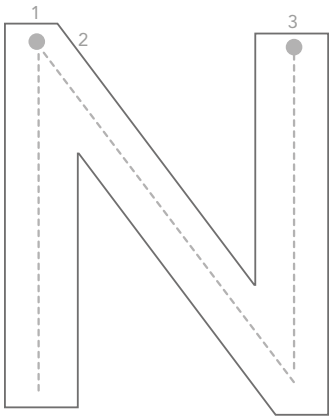

Name _____

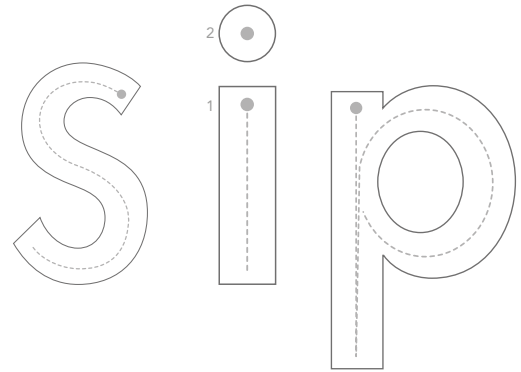
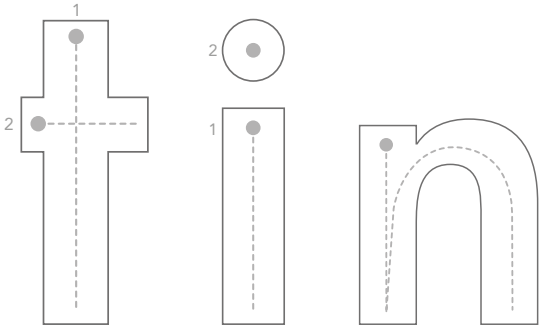

tin _____

sip _____

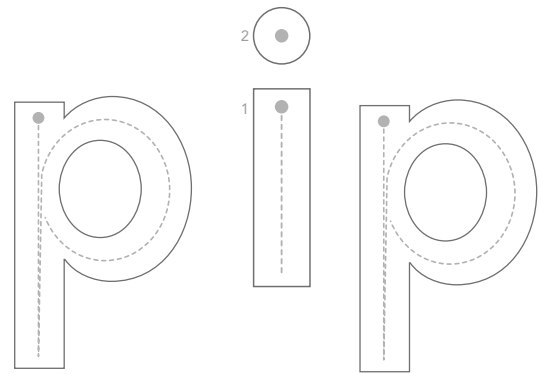
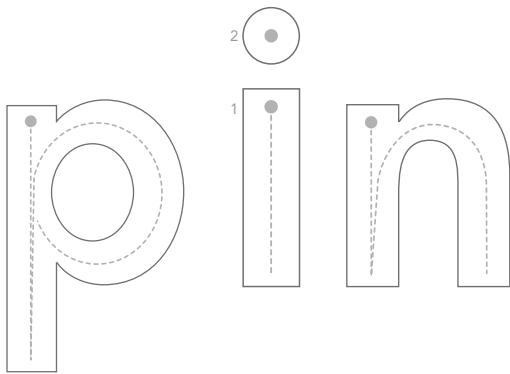

pin _____

pip _____

Name _____

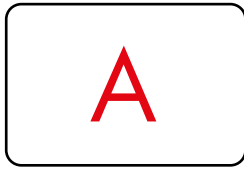
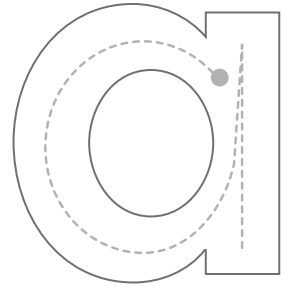
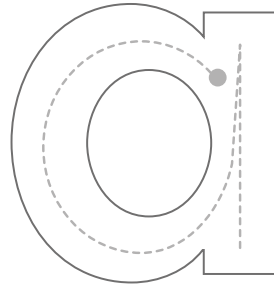
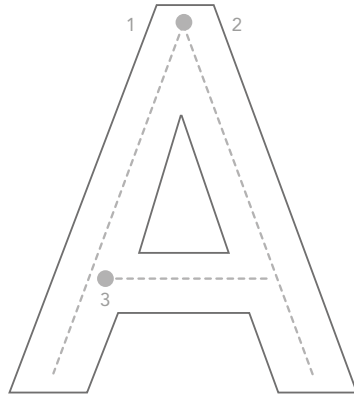
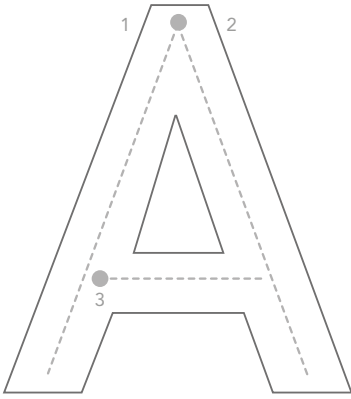

A tap

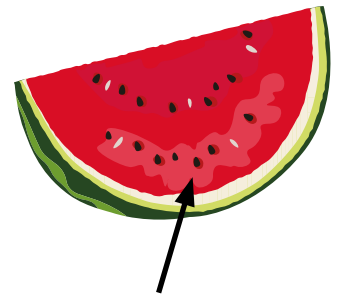

a pip

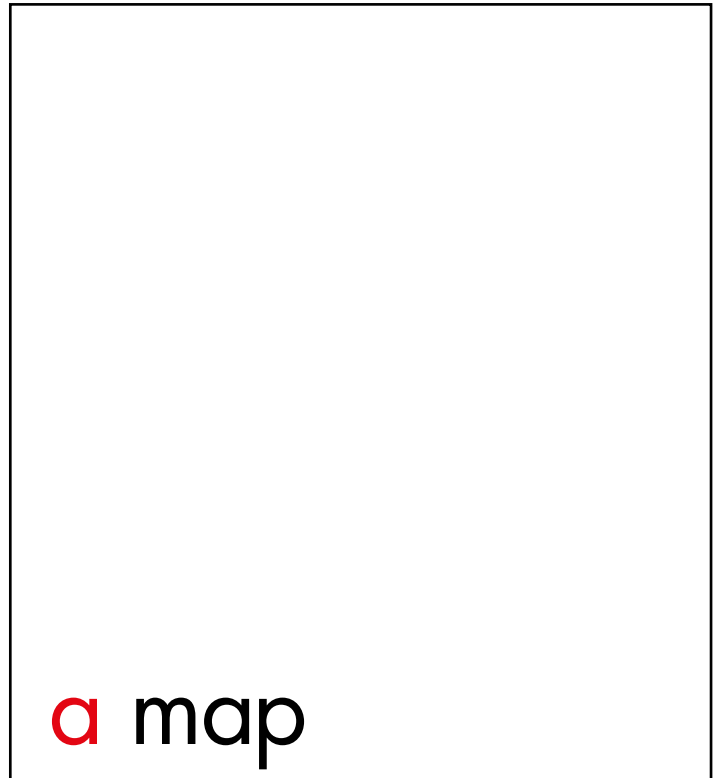

Name _____

I _____

a _____

a pit

a pip

I am Sam.

I am Pam.

Name _____

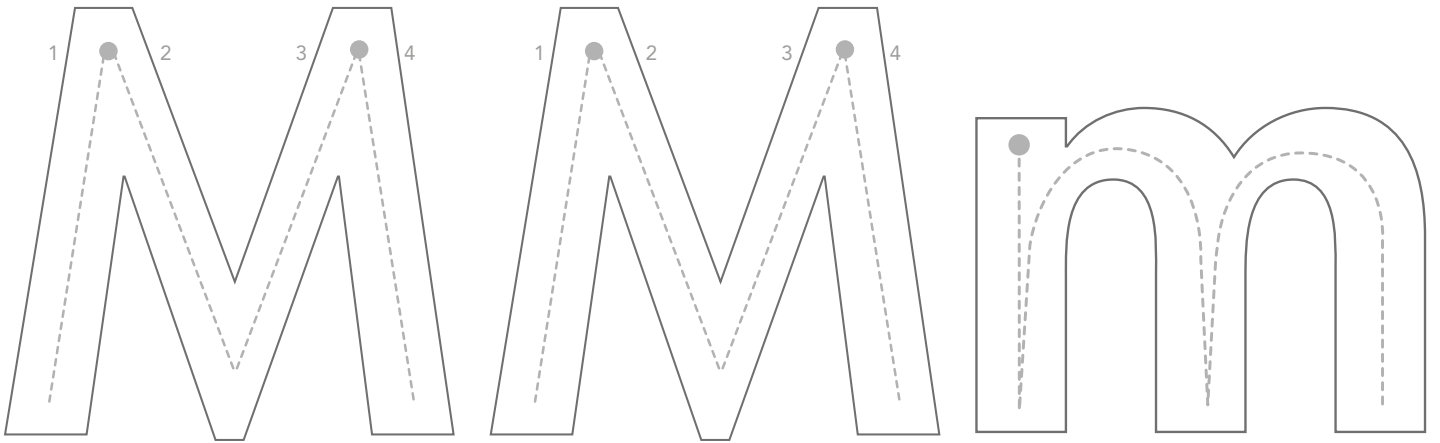

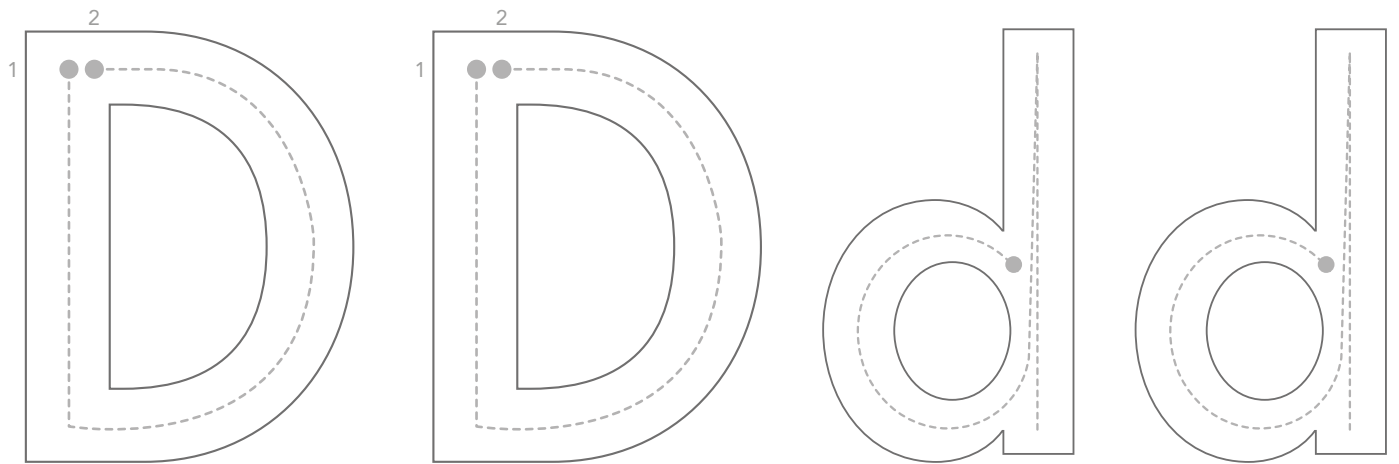

Name _____

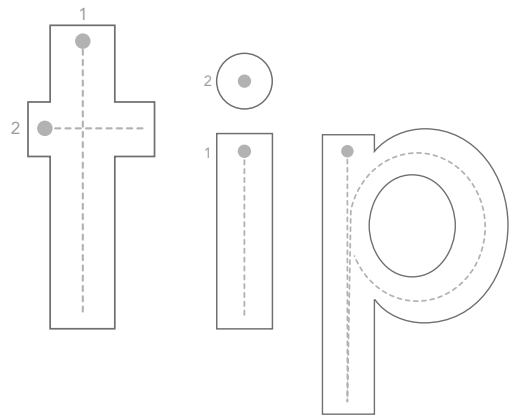
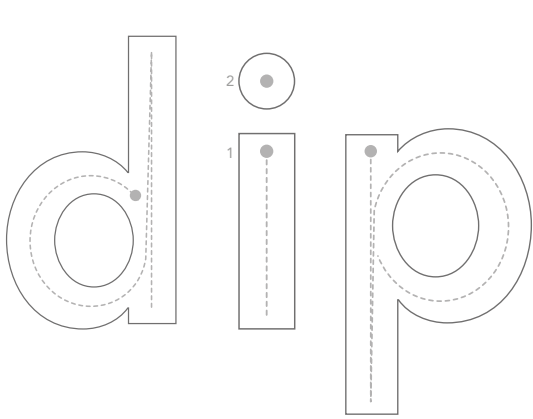

dip _____

tip _____

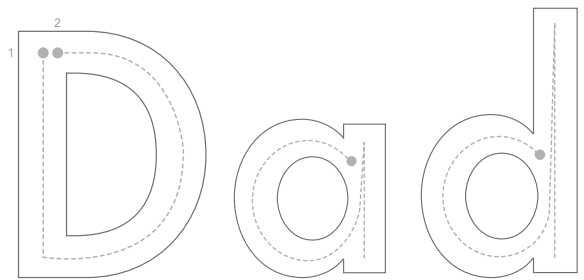

Sam _____

Dad _____

Name _____

is

is

It is Pam.

It is Nat.

It is Nan.

It is Sam.

Name _____

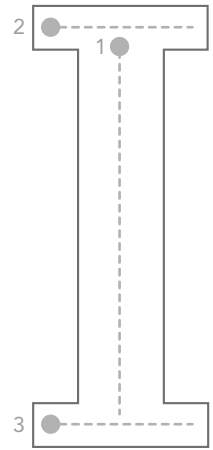
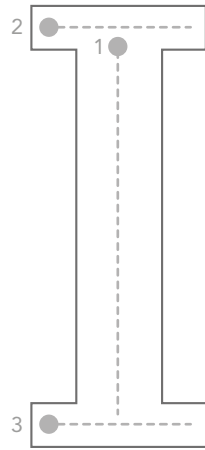
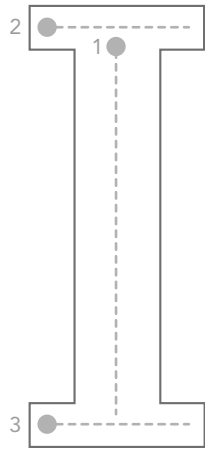
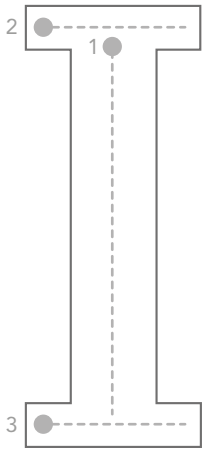

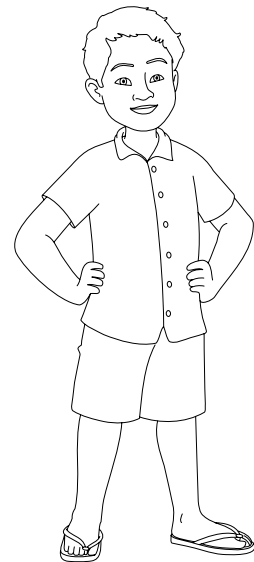
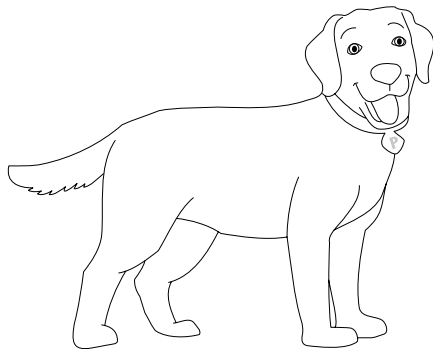

I am Pam.

I am Sam.

Name _____

the

The

the map

The mat

The man

the tap

Name _____

